



# Instruction Manual



## **ES-FLOW™ 1xxC** Ultrasonic Liquid Flow Meter/Controller

Doc. no.: 9.17.153 rev. F    Date: 14-06-2023



### ATTENTION

Please read this document carefully before installing and operating the product.  
Not following the guidelines could result in personal injury and/or damage to the equipment.  
Keep this document for future reference.



## Copyright

© 2023 Bronkhorst High-Tech B.V. - All rights reserved.

Bronkhorst® is a registered trademark of Bronkhorst High-Tech B.V.  
All other trademarks are the property of their respective owners.

## Disclaimer

The illustrations in this document serve to provide general notices regarding correct operation. The illustrations are simplified representations of the actual situation and may differ from the actual product.

Bronkhorst High-Tech B.V. reserves the right to modify or improve its products and documentation without notice. Prior to work, check whether a newer version of this document is available on the Bronkhorst website.

## Symbols in this document



*Important information. Disregarding this information could increase the risk of damage to the equipment, or the risk of personal injuries.*



*Tips, useful information, attention points. This will facilitate the use of the instrument and/or contribute to its optimal performance.*



*Additional information available in the referenced documentation, on the indicated website(s) or from your Bronkhorst representative.*

## Warranty

Bronkhorst® products are warranted against defects in material and workmanship, provided they are used in accordance with the ordering specifications and not subject to abuse or physical damage. Products that do not operate properly during the warranty period may be repaired or replaced at no charge.

The warranty includes all initial and latent defects, random failures, and indeterminable internal causes. It excludes failures and damage caused by the customer, such as contamination, improper electrical hook-up, physical shock, etc.

Re-conditioning of products primarily returned for warranty service that is partly or wholly judged non-warranty may be charged for.

Bronkhorst High-Tech B.V. or affiliated company prepays outgoing freight charges when any part of the service is performed under warranty, unless otherwise agreed upon beforehand. However, if the product has been returned collect to our factory or service center, these costs are added to the repair invoice. Import and/or export charges, foreign shipping methods/carriers are paid by the customer.

## Receipt of equipment

- Check that the outer packaging and its contents have not been damaged during transport. If the outer packaging or its contents are damaged, the local carrier must be informed immediately regarding his liability, if so required. At the same time a report should be submitted to your Bronkhorst representative.
- If the product is damaged, it should not be put into service. In that case, contact your Bronkhorst representative for service.
- Check the packing list to ensure that you received all items included in the scope of delivery.
- Do not discard spare or replacement parts.
- See [Removal and return instructions](#) for information about return shipment procedures.

## Equipment storage

- The equipment should be stored in its original package in a climate controlled storage location.
- Care should be taken not to subject the equipment to excessive temperatures or humidity.
- See technical specifications (data sheet) for information about required storage conditions.



## Table of contents

<b>1</b>	<b>Introduction</b> .....	<b>7</b>
1.1	Scope of this document .....	7
1.2	Intended use .....	7
1.3	Product overview .....	8
1.4	Documentation .....	9
<b>2</b>	<b>Safety notes</b> .....	<b>10</b>
2.1	Tips and warnings .....	10
<b>3</b>	<b>Product specifications</b> .....	<b>12</b>
3.1	Pressure rating .....	12
3.2	Wetted materials .....	12
3.3	Model key .....	13
3.3.1	Customized I/O options .....	13
<b>4</b>	<b>Installation</b> .....	<b>16</b>
4.1	Mounting .....	16
4.1.1	Location .....	16
4.1.2	Orientation .....	16
4.2	Fluid connections .....	16
4.3	Electrical connections .....	17
4.4	Fieldbus connection .....	17
<b>5</b>	<b>Operation</b> .....	<b>18</b>
5.1	Powering up .....	18
5.2	First use .....	18
5.3	Powering down .....	18
5.4	Control valve .....	18
5.4.1	Bleeding .....	18
5.4.2	Default valve state .....	19
5.5	Hardware controls .....	19
5.5.1	Multifunctional switch .....	19
5.5.1.1	Normal operating functions .....	19
5.5.1.2	Power-up functions .....	20
5.5.1.3	Control mode - readout/change .....	20
5.5.1.4	Network settings - readout/change .....	21
5.5.1.5	Disabling multifunctional switch .....	22
5.6	Adjusting zero point .....	22
5.6.1	Manual procedure .....	23
5.6.2	Digital procedure .....	23
5.6.3	Digital procedure on PROFIBUS DP .....	24
<b>6</b>	<b>Digital communication</b> .....	<b>25</b>
6.1	RS-232 communication .....	25
6.2	Fieldbus communication .....	25
6.3	Parameters .....	25
6.3.1	Measurement and control .....	26
6.3.1.1	Advanced measurement and control .....	27
6.3.1.2	Secondary outputs .....	27

---

6.3.2	Alarms .....	28
6.3.3	Counter .....	30
6.3.4	Network configuration .....	31
6.3.5	Fluid .....	33
6.3.6	Controller .....	34
6.3.7	Master/slave configuration (FLOW-BUS) .....	35
6.3.8	Device identification .....	36
6.3.9	Special parameters .....	37
6.3.9.1	Default control mode .....	38
<b>7</b>	<b>Maintenance .....</b>	<b>40</b>
7.1	Cleaning .....	40
7.2	Calibration .....	40
<b>8</b>	<b>Troubleshooting and service .....</b>	<b>41</b>
8.1	LED indications .....	41
8.2	Common issues .....	42
8.3	Service .....	44
<b>9</b>	<b>Returns .....</b>	<b>45</b>
9.1	Removal and return instructions .....	45
9.2	Disposal (end of lifetime) .....	45
	<b>Parameter index .....</b>	<b>47</b>

# 1 Introduction

## 1.1 Scope of this document



The **ES-FLOW™ 1xxC** is a precise and compact volume flow meter/controller for liquids, based on a novel ultrasonic technology. A wide range of liquids can be measured independent of fluid density, temperature and viscosity.

Measuring is done in a straight tube, where multiple transducers measure both the surface acoustic wave and the transit time through the media. All upstream and downstream combinations are recorded and processed in nanoseconds. The sound wave velocity and the surface area are recalculated to the volume flow rate. This ultrasonic measuring method is fast, accurate and inherently bi-directional.

The ES-FLOW™ 1xxC can be operated with analog signals or digitally with RS-232 communication (ProPar) or an extensive range of fieldbus protocols. An on-board PID controller can be used to drive a control valve or pump, establishing a complete yet compact control loop.

This document covers general product information, installation and operating instructions and troubleshooting tips for the ES-FLOW™ 1xxC.

## 1.2 Intended use

The **ES-FLOW™ 1xxC** has been developed to accurately measure and/or control volume flow rates of liquids in a fluid system, with high precision and a limited pressure drop. The device is suited for general purpose indoor (dry) applications, like laboratories and machine enclosures.

Any other use than mentioned here is considered unintended.

Responsibility for the use of the equipment with regard to its intended use, suitability for the intended application, cleaning and compatibility of process media with the applied materials lies solely with the end user.

Bronkhorst High-Tech B.V. cannot be held liable for any damage and/or injury resulting from unintended, improper or unsafe use, or use with other media and/or under other process conditions than specified at ordering time.

### 1.3 Product overview

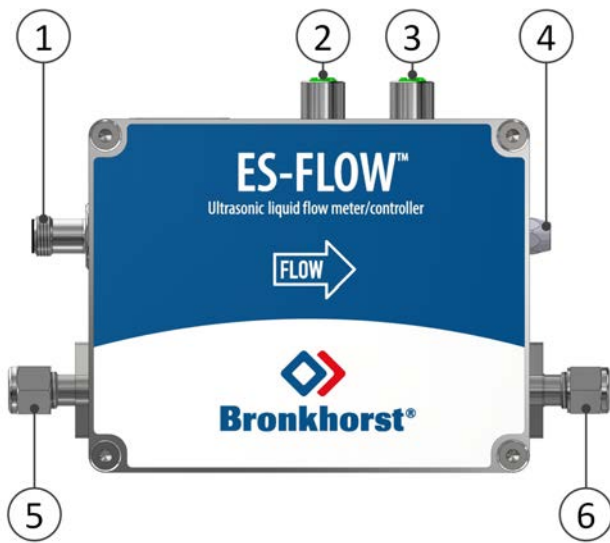

#### Front

1. [Power & signal connector](#)
2. [Fieldbus connector 1 \(optional\)](#)
3. [Fieldbus connector 2 \(optional\)](#)
4. [Actuator output connector](#)
5. [Fluid inlet](#)
6. [Fluid outlet](#)

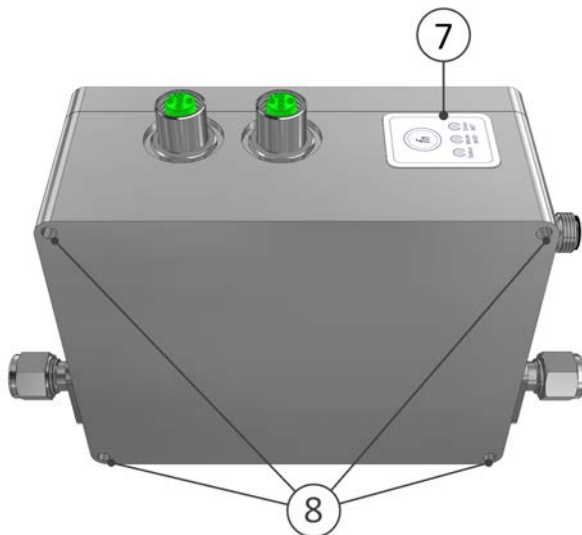

#### Rear & top

7. [Indication LEDs](#) and [multifunctional switch](#)
8. [Mounting holes](#)



## 1.4 Documentation

The ES-FLOW™ comes with all necessary documentation for basic operation and maintenance. At some points this document refers to other documents, which can be downloaded from the Bronkhorst website.



The documentation listed in the following table is available on the **ES-FLOW™** product pages under [www.bronkhorst.com/products](http://www.bronkhorst.com/products)

Type	Document name	Document no.
Manuals	Instruction Manual ES-FLOW™ 1xxC (this document)	9.17.153
Technical documentation	Hook-up diagram Analog/RS-232	9.16.254
	Hook-up diagram CANopen	9.16.259
	Hook-up diagram DeviceNet™	9.16.255
	Hook-up diagram EtherCAT® / EtherNet/IP / Modbus-TCP / POWERLINK / PROFINET	9.16.264
	Hook-up diagram FLOW-BUS	9.16.256
	Hook-up diagram Modbus	9.16.257
	Hook-up diagram PROFIBUS DP	9.16.258
	Hook-up diagram optional bus and I/O configurations	9.16.260
	Dimensional drawing	7.15.220



The documentation listed in the following table can be downloaded from [www.bronkhorst.com/downloads](http://www.bronkhorst.com/downloads)

Type	Document	Document no.
Manuals	Manual CANopen interface	9.17.131
	Manual DeviceNet™ interface	9.17.026
	Manual EtherCAT® interface	9.17.063
	Manual EtherNet/IP interface	9.17.132
	Manual FLOW-BUS interface	9.17.024
	Manual Modbus interface	9.17.035
	Manual POWERLINK interface	9.17.142
	Manual PROFIBUS DP interface	9.17.025
	Manual PROFINET interface	9.17.095
	Manual RS-232 interface	9.17.027
Certificates	EU Declaration of Conformity (EMC, RoHS)	9.06.021
	Manufacturer Declaration REACH	9.06.056
	Manufacturer Declaration WEEE	9.06.128
	Conflict Minerals Compliance Policy	9.06.065

## 2 Safety notes



**Please read this document entirely and carefully before installing and operating the product. Not following the guidelines could result in personal injury and damage to the product and the system(s) it is incorporated in or connected with.**

- The product(s) described in this document may only be handled by qualified personnel who are familiar with combined fluid and electrical systems and who recognize the associated hazards (e.g. (high) fluid pressure, electric shock).
- The user is responsible for taking the necessary safety measures to prevent damage and/or injury while working with the equipment and process media (as described in the associated Material Safety Data Sheets).
- Where appropriate, this document recommends or prescribes safety measures to be taken with respect to media or equipment usage under the specified conditions. However, this does not relieve the user of aforementioned responsibility, not even if such is not explicitly recommended or prescribed in this document.
- The equipment and its accessories must be used in accordance with their specifications and intended use.
- The customer is responsible for conducting a risk analysis for the entire system and take the required safety precautions following applicable laws and regulations. Based on the risk analysis, the customer should describe and adhere to standard operating procedures to ensure safe use of the equipment.
- Individual instruments may not be disassembled or modified in any way or for any purpose.
- Any unauthorized modification, for any purpose whatsoever, will be considered as [unintended and improper use](#), will void warranty and cancel the manufacturer's liability.
- Unauthorized modifications can undo safety features, compromise system specifications (such as ingress protection rating) and cause failure to comply with applicable laws, regulations and directives.
- If the product is defective or otherwise does not meet your requirements, please contact your Bronkhorst representative for assistance or advice.

### 2.1 Tips and warnings



At the factory the ES-FLOW™ has been pressure tested. The operating pressure must never exceed the specified test pressure.

- The pressure rating and the tested pressure are specified on the serial number label; if these specifications are missing or insufficient, the device must not be used and should be returned to the factory.
- Before installation, make sure that the pressure rating is within the limits of the normal process conditions and that the tested pressure is in accordance with the safety factor of your application.
- Disassembling the device and/or replacing parts will invalidate the pressure test specification.



Before commissioning, always check the wetted materials for compatibility with the process media.



Do not apply fluid pressure until all required fluid connections and electrical connections have been made.



Check the fluid system for leak tightness after any modification and before applying full operating pressure, especially when using hazardous media (e.g. toxic or flammable).



In order to be able to comply with all applicable guidelines and regulations, it is essential that electrical connections be made by or under supervision of a qualified electrician.



- The equipment described in this document contains electronic components that are susceptible to **electrostatic discharge**.
- When working on the electrical installation, take appropriate measures to prevent damage as a result of electrostatic discharge.



The **CE mark** on the equipment indicates that it complies with requirements imposed by the European Union, including **electromagnetic compatibility (EMC)**.

EMC can only be guaranteed by applying appropriate cables and connectors or gland assemblies:

- Cable wire diameters must be sufficient to carry the supply current and minimize voltage loss.
- When connecting the product to other devices, ensure that the integrity of the shielding remains uncompromised; use shielded cables and connectors where possible and/or required.
- Preferably use the supplied cables (if applicable) to make electrical (signal) connections to and between the supplied components. These cables are shielded, have the required wire diameter, and loose ends (if applicable) are marked to facilitate correct connection.

If not all requirements for proper shielding can be met (for example, because a component is not equipped with shielded connectors), take the following measures to ensure the best possible shielding:

- Keep cable lengths at a minimum.
- Route cables as closely as possible alongside metal structures or components.
- Ensure all electrical components are grounded to earth.

When in doubt about the shielding of your cabling and/or electrical connections, contact your Bronkhorst representative.



Always turn off electrical power before connecting or disconnecting equipment electrically.



When pressurizing, prevent pressure shocks by gradually bringing the fluid system to the required operating pressure.



Bronkhorst does the utmost to ensure that you receive a clean product. This does not, however, relieve the user of the responsibility to ensure that the equipment and the system in which it is incorporated meet the requirements implied by the intended use of the product. The responsibility for cleaning the equipment to meet such requirements lies exclusively with the user.



- Prior to powering down the ES-FLOW™, the fluid system should be depressurized.
- When depressurizing, prevent pressure shocks by shutting off the fluid supply gradually.



Inexpertly servicing instruments can lead to serious personal injury and/or damage to the instrument or the system it is used in. Servicing must therefore be performed by trained and qualified personnel. Contact your Bronkhorst representative for information about cleaning and calibration. Bronkhorst has trained staff available.



- Before disconnecting or disassembling any fluid system related parts, always make sure the fluid system is depressurized to atmospheric pressure.
- When depressurizing, prevent sudden pressure changes by shutting off the fluid supply gradually.



Frequent inspection of all fluid lines and connections before, during and after operation is essential, to ensure and maintain a safe working environment. If necessary, re-tighten fluid connections.

### 3 Product specifications

Before installing the ES-FLOW™, check that the product specifications match your requirements.

The model key (second line on the serial number label) contains information about the technical properties of the product as ordered. The actual properties of your product can be retrieved from the diagram below.



If you have a question about the product or if you find the product does not meet the specifications agreed upon, do not hesitate to contact your Bronkhorst representative. To enable us to help you quickly and effectively, make sure to have the serial number (SN) ready whenever seeking contact with your Bronkhorst representative about a specific item.

See section [Service](#) for contact information.

#### 3.1 Pressure rating



*At the factory the ES-FLOW™ has been pressure tested. The operating pressure must never exceed the specified test pressure.*

- *The pressure rating and the tested pressure are specified on the serial number label; if these specifications are missing or insufficient, the device must not be used and should be returned to the factory.*
- *Before installation, make sure that the pressure rating is within the limits of the normal process conditions and that the tested pressure is in accordance with the safety factor of your application.*
- *Disassembling the device and/or replacing parts will invalidate the pressure test specification.*

#### 3.2 Wetted materials



*Before commissioning, always check the wetted materials for compatibility with the process media.*

### 3.3 Model key

The model key on the serial number label contains information about the technical properties of the product as ordered. The actual properties of your instrument can be retrieved from the diagram below.

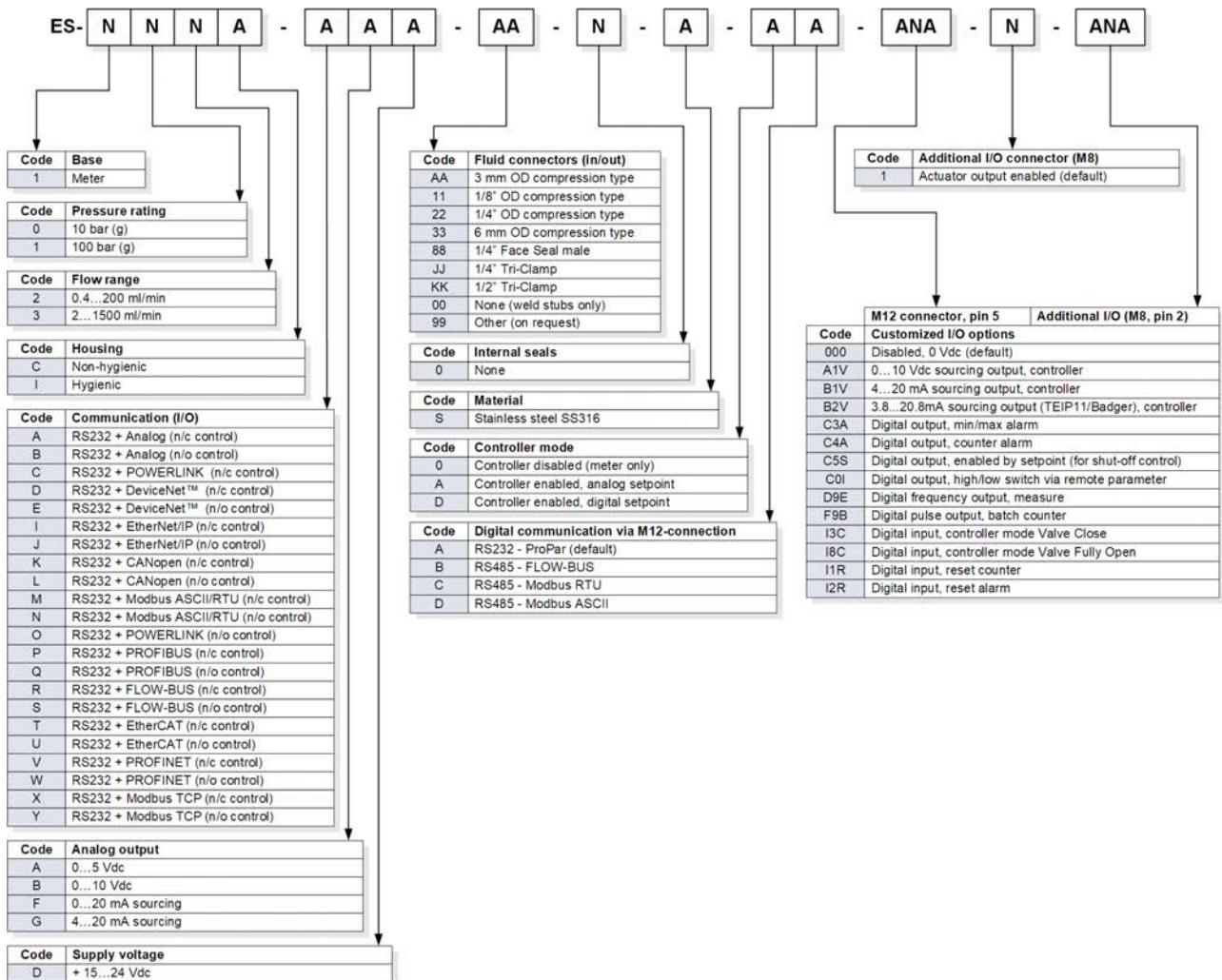

#### 3.3.1 Customized I/O options

ES-FLOW™ 1xxC instruments offer various customized input/output functions through pin 5 of the [power connector](#) and through pin 2 of the [actuator output connector](#) as an option. I/O options are factory installed as specified at ordering time, and cannot be changed.

The last 3 groups of the model key on the serial number label indicate the installed I/O configuration. The possible configurations are described in the table below. See the [hook-up diagram](#) for custom bus and I/O configurations for an explanation of the codes.

Code	Description
000	Disabled, pin 5 is pulled down to 0 Vdc (default selection)
A1V*	0...10 Vdc sourcing output, controller Analog signal for pump or external valve steering (control signal only)
	When the controller output is used for pump or external valve steering (mass flow meters only), make sure to set parameter <i>Valve maximum</i> to 0.3 [A]. For mass flow controllers, the controller output is limited to a value below 10Vdc, due to the maximum valve current restriction.

Code	Description
B1V*	<p>4...20 mA sourcing output, controller Analog signal for pump or external valve steering (control signal only).</p> <p>When the controller output is used for pump or external valve steering (mass flow meters only), make sure to set parameter <i>Valve maximum</i> to 0.3 [A]. For mass flow controllers, the controller output is limited to a value below 20 mA, due to the maximum valve current restriction.</p>
B2V*	<p>3.8...20.8 mA sourcing output, controller Analog signal for Badger Meter valve with TEIP11 signal converter (control signal only)</p>
C3A	<p>Digital output, min/max alarm During a min/max alarm, pin 5 is pulled down to 0 Vdc.</p>
C4A	<p>Digital output, counter alarm During a counter alarm, pin 5 is pulled down to 0 Vdc.</p>
C5S	<p>Digital output, enabled by setpoint (for shut-off control) Pin 5 is pulled down to 0 Vdc at a controller setpoint, e.g. for shut-off valve activation.</p> <p>For factory selected analog control (...-A#-C5S): If parameter <i>Control mode</i> is set for analog control by factory, the minimum setpoint at which the device (shut-off valve) connected to pin 5 is activated is 1.9%. This prevents possible noise on the analog input activating the device accidentally.</p> <p>For factory selected digital control (...-D#-C5S): If parameter <i>Control mode</i> is set for digital control by factory, the setpoint threshold for activating the device connected to pin 5 is any value &gt; 0.</p> <p>Note: If the instrument is forced into Valve Safe State, the digital output is not affected, so a (n.c.) shut-off valve connected to pin 5 will not close when the (n.c.) controller is in Valve Safe State'</p> <p>Make sure to use 24 Vdc power supply corresponding to the shut-off valve specifications.</p>
COI	<p>Digital output, high/low switch via remote parameter (e.g. for shut-off valve control) Pin 5 is pulled down to 0 Vdc when writing value 1 to parameter <i>IO switch status</i>, this is undone by writing value 0.</p> <p>A device connected to pin5 (e.g. a shut-off valve) can be activated/deactivated by writing parameter <i>IO switch status</i>.</p> <p>Note: If the instrument is forced into Valve Safe State, the digital output is also affected, so a (n.c.) shut-off valve connected to pin 5 will be closed when the (n.c.) controller is in 'Valve Safe State'.</p> <p>Make sure to use 24 Vdc power supply corresponding to the shut-off valve specifications.</p>
D9E	<p>Digital frequency output, measure Measurement value is translated to a frequency within given frequency range.</p> <p>The default frequency range to represent 0...100% flow is 0...10000 Hz. Any other frequency range must be specified on order.</p>
F9B	<p>Digital pulse output, batch counter Pin 5 is pulled down to 0Vdc when a given batch size is reached (during a given pulse length).</p> <p>By default, a pulse is given at each 1x the <i>Counter unit</i> batch value, with a pulse length of 1 second. For instance, when <i>Counter unit</i> is set to 'ln', a pulse is given each time 1 ln has passed through the instrument. An alternative pulse length must be specified on order.</p> <p>Provide a pull-up resistor of 5...10 kOhm to create 15...24 Vdc at pin 5 (according to the applicable hook-up diagram).</p>
I3C	<p>Digital input, controller mode valve close Valve closes when pin 5 is connected to 0 Vdc.</p> <p>This option switches between the default <i>Control mode</i> and mode 'Valve Close' (value 3). When the default <i>Control mode</i> is digital, the default value is 0 (bus/RS-232), when the default <i>Control mode</i> is analog, the default value is 1 (Analog input).</p>

Code	Description
I8C	Digital input, controller mode valve purge Valve is fully opened when pin 5 is connected to 0 Vdc.  This option switches between the default <i>Control mode</i> and mode 'Valve Fully Open' (value 8). When the default <i>Control mode</i> is digital, the default value is 0 (bus/RS-232), when the default <i>Control mode</i> is analog, the default value is 1 (Analog input).
I1R	Digital input, reset counter The counter resets when pin 5 is connected to 0 Vdc.
I2R	Digital input, reset alarm The alarm resets when pin 5 is connected to 0 Vdc.



**\*) Notes regarding controller options:**

- A controller output option (A1V, B1V or B2V) can only be installed in combination with controller mode A or D (controller enabled, see model key).
- If the controller is enabled, the M8 connector can always be used to control a Bronkhorst® valve (through pin 3).
- Although it is theoretically possible to have 3 controller options installed, no more than 1 signal should be used at any time.

## 4 Installation

### 4.1 Mounting



For stable fixation to a rigid and stable surface or construction, use the threaded mounting holes in the rear of the instrument housing (see [product overview](#)). Consult the [dimensional drawing](#) for the exact size and locations.

#### 4.1.1 Location

Gas bubbles in the liquid can lead to measuring errors. In general, the instrument should be mounted in a pipe segment where gas bubbles cannot accumulate. The image on the right shows the preferable mounting locations.

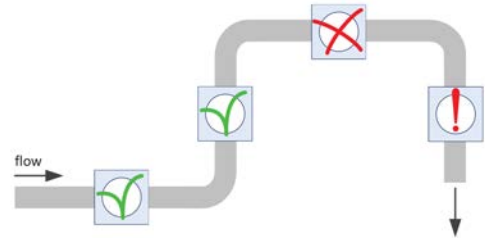

- In general, the best location is a horizontal pipe segment or a segment where the fluid direction is upward.



- Gas might accumulate in the horizontal segment if it is followed by a downward segment. Do not mount the instrument in a location like this.



- Mounting in a downward pipe segment with an open end is strongly dissuaded, especially if the pipe diameter is 1/2" or more. Gravity might let the segment run empty; depending on the specific system dimensions and the viscosity of the metered fluid, this effect might be stronger or weaker.
- If the instrument is part of a closed fluid system, mounting the instrument in a downward pipe segment is not preferable, but may be considered if other mounting locations are problematic.



To minimize the risk of gas bubbles caused by cavitation, the preferred location to install a (control) valve is downstream from the instrument, the preferred location for a pump is upstream.



To prevent damage to the internal electronics, make sure the temperature inside the instrument housing does not get above 60 °C. If necessary, take appropriate heat dissipation measures, especially if the instrument is operated inside an enclosure (e.g. a control cabinet).

#### 4.1.2 Orientation

Aside from specific application requirements, the ES-FLOW™ has no preferred mounting orientation.

## 4.2 Fluid connections

For regular (mono-directional) use, install the ES-FLOW™ in the process line, in accordance with the direction of the FLOW arrow on the instrument. For bi-directional measuring, install the instrument in the direction in which the highest flow will be measured (if applicable). When deciding which direction to install the instrument in, take into account that the measuring range in the reverse direction is approximately 73% of the full scale range (whereas the instrument can measure 131% FS in the normal direction).

Tighten fittings according to the instructions issued by their manufacturer.



Do not apply fluid pressure until all required fluid connections and electrical connections have been made.



Check the fluid system for leak tightness after any modification and before applying full operating pressure, especially when using hazardous media (e.g. toxic or flammable).



### 4.3 Electrical connections

- Electrical connections must be made with standard cables or compatible, according to the [hook-up diagram](#).
- When using self-assembled cables, follow the guidelines provided by the connectors' manufacturer.
- For use in a fieldbus system, follow the instructions of the cable supplier for the according fieldbus system.
- Make sure that the power supply is suitable for the power ratings as indicated on the serial number label ([model key](#)), and that double or reinforced insulation is used for the power supply.
- Before powering up, make sure all required cabling is properly connected.
- Before each use, inspect cabling and connectors for damage.



*In order to be able to comply with all applicable guidelines and regulations, it is essential that electrical connections be made by or under supervision of a qualified electrician.*



- *The equipment described in this document contains electronic components that are susceptible to **electrostatic discharge**.*
- *When working on the electrical installation, take appropriate measures to prevent damage as a result of electrostatic discharge.*



*The **CE mark** on the equipment indicates that it complies with requirements imposed by the European Union, including **electromagnetic compatibility (EMC)**.*

*EMC can only be guaranteed by applying appropriate cables and connectors or gland assemblies:*

- *Cable wire diameters must be sufficient to carry the supply current and minimize voltage loss.*
- *When connecting the product to other devices, ensure that the integrity of the shielding remains uncompromised; use shielded cables and connectors where possible and/or required.*
- *Preferably use the supplied cables (if applicable) to make electrical (signal) connections to and between the supplied components. These cables are shielded, have the required wire diameter, and loose ends (if applicable) are marked to facilitate correct connection.*

*If not all requirements for proper shielding can be met (for example, because a component is not equipped with shielded connectors), take the following measures to ensure the best possible shielding:*

- *Keep cable lengths at a minimum.*
- *Route cables as closely as possible alongside metal structures or components.*
- *Ensure all electrical components are grounded to earth.*

*When in doubt about the shielding of your cabling and/or electrical connections, contact your Bronkhorst representative.*



*Always turn off electrical power before connecting or disconnecting equipment electrically.*

### 4.4 Fieldbus connection



***Never** power the instrument simultaneously from **two different power sources** (e.g. fieldbus and Plug-in Power Supply). Doing so will irreversibly damage the printed circuit board and the instrument will have to be repaired before it can be used.*



*Always check the total power consumption of your instruments before connecting them to a fieldbus system. Do not exceed the maximum power of the power supply unit.*



- *For information about setting up a fieldbus network with Bronkhorst® instruments, consult the according [fieldbus manual](#).*
- *If you need assistance with setting up a fieldbus network, contact your Bronkhorst representative for information.*

## 5 Operation

### 5.1 Powering up



To maintain control of the fluid system and ensure a safe situation, it is recommended to turn on power before applying fluid pressure and to switch off power only after the fluid system is depressurized.



When pressurizing, prevent pressure shocks by gradually bringing the fluid system to the required operating pressure.



For best performance, allow the device to warm up and stabilize for at least 60 minutes before starting measurement and/or control. This may be done with or without media flow.

- After powering up, the instrument needs a couple of seconds to start up the electronics and perform a self-test. After successful initialization, the green LED will light up continuously to indicate that the instrument is ready to use.
- After powering up, the control valve will act according the last known setpoint. When setpoint is 0, this means the valve closes (normally open) or stays closed (normally closed). The valve stays closed until the instrument receives a new valid setpoint from the active setpoint source.
- If the sensor tube contains gas, the red LED will light up continuously and the instrument will issue a warning code by means of parameter *Alarm Info* (see [Alarms](#)).

### 5.2 First use



Bronkhorst does the utmost to ensure that you receive a clean product. This does not, however, relieve the user of the responsibility to ensure that the equipment and the system in which it is incorporated meet the requirements implied by the intended use of the product. The responsibility for cleaning the equipment to meet such requirements lies exclusively with the user.



Before starting measurement and control, make sure to remove gas from the fluid system by flushing all fluid lines with the process fluid at a high flow rate.

### 5.3 Powering down



- Prior to powering down the ES-FLOW™, the fluid system should be depressurized.
- When depressurizing, prevent pressure shocks by shutting off the fluid supply gradually.

### 5.4 Control valve

This section is only applicable if the ES-FLOW™ is used in conjunction with a control valve.

#### 5.4.1 Bleeding

In order to ensure stable and reliable control behavior, the dead space of the control valve should be kept free of gas, by bleeding it from time to time. Bleeding is advised at the following occasions:

- prior to first use
- when restarting the instrument after purging
- periodically, to remove accumulated gas



- Make sure to connect the bleed outlet to an appropriate draining facility, especially if the system is used to process hazardous media.
- Take appropriate safety measures, as described in the Material Safety Data Sheet(s) of the process media (if applicable).



Install a shut-off valve as close to the bleed outlet as possible and connect a clear transparent tube to the valve outlet; being able to see gas bubbles in the liquid will ease monitoring the progress of the bleeding procedure.

To bleed the control valve, follow this procedure:

1. Change the liquid flow setpoint to 0% (this closes the valve).
2. Pressurize the liquid inlet (if not already done so).
3. Open the bleed outlet (slowly) until liquid starts to escape.
4. Optionally, tap the valve assembly and/or liquid inlet of the valve to let gas bubbles accumulate and migrate to the valve.
5. Close the bleed outlet as soon as all gas has escaped the control valve.

## 5.4.2 Default valve state

When a controlling instrument is not powered or cannot communicate with the fieldbus network (if applicable), all electrical valves operated by the instrument (whether integrated or external) automatically return to their default state. The default state is closed for 'normally closed' valves (n/c) and fully open for 'normally open' valves (n/o).

Check the serial number label or the [technical specifications](#) to see which valve type is used on your instrument (if applicable).

## 5.5 Hardware controls

On top of the housing the instrument is equipped with a multifunctional switch (fn) and three indication LEDs:

Status                    Communication interface status  
 Mode/MOD            Operational mode  
 Error/NET            Error/warning indication



- During normal operation the *Mode/MOD* indicator is lit green ● continuously, while the *Error/NET* indicator flashes red ● when data is being transferred.
- During initialization and special procedures, the *Mode/MOD* indicator blinks or flashes.
- See the [troubleshooting guide](#) for general error indications and possible causes.
- Several other indications are specific to the installed communication interface.
- The *Status* LED is functional only if the instrument is equipped with an Ethernet based fieldbus interface.
- Consult the according [interface manual](#) for a list of all indications.

### 5.5.1 Multifunctional switch

Some special instrument functions can be started manually using the multifunctional switch near the indication LEDs. These functions are available in analog as well as in digital operation mode.

#### 5.5.1.1 Normal operating functions

- In order to access these functions, press and hold the switch while the instrument is in normal operation mode (green LED lit continuously).
- As long as the switch is held, the LEDs show a repeating sequence of patterns, where each pattern indicates a function.
- All patterns in this sequence are continuous.
- Each pattern is shown for a number of seconds; in the table below, the column labeled *Hold time* indicates the time frame during which a pattern is shown.
- To start the required function, release the switch when the LEDs show the associated pattern.



● (green)	● (red)	Hold time	Function
off	off	0...1 sec	No action
off	off	1...4 sec	1. In case of a min/max alarm: reset alarm 2. FLOW-BUS: Auto-install to bus - lets instrument obtain free node address Note: min/max alarm (if any) has to be reset before auto install can be performed.
off	on	4...8 sec	Reset instrument; clear all warnings and error messages and restart the instrument
on	off	8...12 sec	Auto-zero; re-adjust the zero-point of the instrument (flow meters/controllers only)
on	on	12...16 sec	Enable FLASH mode for firmware update: <ul style="list-style-type: none"> <li>• the instrument shuts down and both LEDs are switched off</li> <li>• at the next power-up, the instrument will be active again</li> </ul>



- See [Adjusting zero point](#) for background information and instructions on how to adjust the zero point of an instrument.
- Do not adjust the zero point before having taken notice of the instructions.

### 5.5.1.2 Power-up functions





- In order to access these functions, press and hold the switch while powering up the instrument.
- As long as the switch is held, the LEDs show a repeating sequence of patterns, where each pattern indicates a function.
- All patterns in this sequence are flashing (0.2 sec on, 0.2 sec off).
- Each pattern is shown for a number of seconds; in the table below, the column labeled *Hold time* indicates the time frame within the sequence during which a pattern is shown.
- To start the required function, release the switch when the LEDs show the associated pattern.

 (green)	 (red)	Hold time	Function
off	off	0...4 sec	No action
off	on	4...8 sec	Restore factory settings (except communication settings)
on	off	8...12 sec	<ul style="list-style-type: none"> <li>• FLOW-BUS: auto install to bus; let the instrument obtain a free node address from the FLOW-BUS system</li> <li>• Other protocols: no action</li> </ul>
on	on	12...16 sec	Activate or deactivate configuration mode <ul style="list-style-type: none"> <li>• The power and signal connector is set to RS-232 communication (<a href="#">ProPar</a>) at baud rate 38400</li> <li>• In configuration mode, the green LED blinks (2 seconds on, 0.1 second off)</li> <li>• Deactivate configuration mode by selecting this function again at the next power-up</li> </ul>

### 5.5.1.3 Control mode - readout/change

#### Reading control mode

- By briefly pressing the switch 2 times within 1 second in normal operation mode, the instrument shows its current control mode with a series of consecutive LED indication patterns.
- The number of flashes corresponds to the current value of parameter *Control Mode* (see [Special parameters](#)).





Step	Pattern	Indication
1	Green  	number of flashes indicates the tens of the parameter value
2	Red  	number of flashes indicates the units of the parameter value

Examples:

- for value 1 (control mode 'Analog input'), the green LED will flash 0 times and the red LED 1 time
- for value 22 (control mode 'Valve Safe State'), the green and red LED will each flash 2 times

#### Changing control mode

- By briefly pressing the switch 4 times with intervals of up to 1 second in normal operation mode, the instrument enters a state in which the control mode can be changed.
- This is done in 2 steps, each represented by a LED indication pattern (green or red; see table below).
- The number of flashes corresponds to the available values of parameter *Control Mode* (see [Special parameters](#)).
- At the start of each step, the according LEDs starts flashing fast (0.1 second on, 0.1 second off). By pressing and holding the switch, the associated action is started and the flashing slows (0.5 seconds on, 0.5 seconds off).

Step	Pattern	Maximum flash count	Action
1	Green  	2	set tens of parameter value
2	Red  	9	set units of parameter value

To execute a step, follow these instructions:

- Press and hold the switch (flashing slows)
- To select value 0 (zero), release the switch within 1 second, otherwise:
- Count the number of LED flashes
- Release the switch when the required value is reached
- In case you lose count, keep the switch pressed and wait until the flash count reaches its maximum and restarts

On completion of step 1, the instrument automatically advances to step 2. When both steps have been completed, the instrument returns to its normal operation mode.

If the switch is not pressed within 60 seconds after starting a step, all changes are canceled and the instrument returns to its normal operation mode.









Note that this procedure also sets the [default control mode](#) of the instrument (contrary to changing the control mode digitally).

#### 5.5.1.4 Network settings - readout/change

##### Reading network settings

- By briefly pressing the switch 3 times with intervals of up to 1 second in normal operation mode, the instrument shows its current node address and baud rate with a series of consecutive LED indication patterns:

Step	Pattern	Indication
1	Green  	number of flashes indicates the tens of the node address
2	Red  	number of flashes indicates the units of the node address
3	Green and red (simultaneous)  	number of flashes indicates the baud rate

Examples:

- for node address 35, the green LED will flash 3 times and the red LED 5 times
- for node address 116, the green LED will flash 11 times and the red LED 6 times





On DeviceNet™ the node address is called MAC ID.

The number of flashes for the baud rate indication is associated with the following baud rates:

Number of flashes (index)	Baud rate					
	FLOW-BUS	Modbus (ASCII/RTU)	PROFIBUS DP	CANopen	DeviceNet™	Ethernet based
0			automatically detected			
1	187500	9600	9600	1000000	125000	100000000
2	400000	19200	19200	800000	250000	
3		38400	45450	500000	500000	
4		56000	93750	250000		
5		57600	187500	125000		
6		115200	500000	50000		
7		128000	1500000	20000		
8		256000	3000000	10000		
9			6000000			
10			12000000			

### Changing network settings

- By briefly pressing the switch 5 times with intervals of up to 1 second in normal operation mode, the instrument enters a state in which the node address and baud rate can be changed (non-Ethernet based protocols only; for Ethernet based protocols, network parameters are configured by the fieldbus master and cannot be set on the instrument).
- Changing network parameters with the multifunctional switch is done in 3 steps, each represented by a LED indication pattern (see table below).
- At the start of each step, the according LED(s) start(s) flashing fast (0.1 second on, 0.1 second off). By pressing and holding the switch, the associated action is started and the flashing slows (0.5 seconds on, 0.5 seconds off).

Step	Pattern	Maximum flash count	Action
1	Green 	12	set tens of node address
2	Red 	9	set units of node address
3	Green and red (simultaneous) 	10*	set baud rate index (number of flashes)

\*) maximum count depends on the supported baud rates of the fieldbus. See the baud rate table above for supported baud rates and associated indexes.

To execute a step, follow these instructions:

- Press and hold the switch (flashing slows)
- To select value 0 (zero), release the switch within 1 second, otherwise:
- Count the number of LED flashes
- Release the switch as soon as the required value is reached
- In case you lose count, keep the switch pressed and wait until the flash count reaches its maximum and restarts

On completion of a step, the instrument automatically advances to the next step. When all required steps have been completed, the instrument returns to its normal operation mode.

If the switch is not pressed within 60 seconds after starting a step, all changes in the previous steps are cancelled and the instrument returns to its normal operation mode.

#### 5.5.1.5 Disabling multifunctional switch

To prevent unwanted use of the multifunctional switch, it can be disabled through the digital interface using the following procedure:

1. Set parameter *Init reset* to 64
2. Read parameter *IO status*
3. Subtract 8 from the read value
4. Write the new value to parameter *IO status*
5. Set parameter *Init reset* to 82

To re-enable the switch, add 8 to the value of *IO status* in step 3.

## 5.6 Adjusting zero point

### Zero-stability

The zero point of a Bronkhorst® flow meter/controller (the measurement signal that indicates the absence of a flow) is factory adjusted with water at approximately 20 °C and atmospheric pressure (ambient conditions), with the instrument positioned upright. Under normal circumstances, the zero point will remain stable. However, in rare cases (for example due to strong fluctuations in temperature and/or pressure), the instrument might develop a slight deviation of the measured value from the zero point, causing it to detect a flow when in reality there is none. Readjusting the zero point eliminates this deviation.



*If the instrument still detects a (steady) flow while all valves are closed and the fluid system is leak tight, re-adjusting the zero point is recommended.*

## Prerequisites

Zeroing an instrument requires that:

- the ambient conditions (temperature, pressure) match those of the operating environment of the instrument.
- the instrument is filled homogeneously and pressurized with the operational media, according to the typical process conditions.
- the instrument has been warmed up sufficiently.
- there is absolutely no flow through the instrument; preferably, this is achieved by closing a valve immediately after the outlet of the instrument (control valve, shut-off valve).



Blocking the flow through the instrument is essential; zeroing an instrument while there is still a flow will lead to measurement errors.

## Procedure

The zeroing procedure can be performed manually (using the multifunctional switch) or digitally, with RS-232 or fieldbus communication

Regardless of the chosen method, the zeroing procedure takes approximately 25 seconds to complete.

### 5.6.1 Manual procedure

To start the autozero function with the [multifunctional switch](#), follow these instructions:

1. Change the setpoint of the instrument to 0 (zero).
2. Press and hold the multifunctional switch. After 4 seconds, the red LED ● lights up; another 4 seconds later the red LED extinguishes and the green LED ● lights up.
3. At that moment (which is after 8 to 12 seconds), release the switch.

The green LED starts to blink fast, indicating that the autozero procedure is in progress. After (successful) completion, the green LED lights up continuously, while the output signal is 0 % (parameter *Measure* = 0).

### 5.6.2 Digital procedure



Bronkhorst FlowSuite and FlowPlot provide an easy way to adjust the zero point of an instrument using RS-232 communication; the Autozero function automatically performs the procedure described here.

To adjust the zero point using digital communication, set parameter values in the following sequence (see section [Parameters](#) for more information about instrument parameters):

Sequence #	Parameter	Value	Action
1	Setpoint or fSetpoint	0	stop flow
2	Init Reset	64	unlock secured parameters
3	Control Mode	9	enable calibration mode
4	Calibration Mode	0	reset calibration mode
5	Calibration Mode	9	start zeroing

On completion of the procedure, parameter *Control Mode* returns to its initial value. If the procedure is successful, parameter *Calibration mode* changes to 0 (idle). If the procedure fails, *Calibration Mode* changes to 255.



After performing the procedure, remember to set parameter Init Reset to value 82 to lock secured parameters.

### 5.6.3 Digital procedure on PROFIBUS DP

For instruments with a PROFIBUS DP interface, the procedure to be followed differs slightly:

To adjust the zero point in a network with cyclic communication, set write parameter values in the following sequence (see section [Parameters](#) for more information about instrument parameters):

Sequence #	Parameter	Value	Action
1	Setpoint or fSetpoint	0	stop flow
2	Initreset	64	unlock secured parameters
3	Calibration Mode	0	reset calibration mode
4	Calibration Mode	22	start zeroing
5	Calibration Mode	0	reset calibration mode



*In cyclic communication, it is important to reset Calibration Mode after the procedure is started, but before it finishes. By keeping Calibration mode at value 22, the procedure will be started again immediately after it finishes.*

After starting the zeroing procedure, the value of read parameter *Calibration Mode* changes to 9, to indicate that the procedure is running. Upon completion, *Calibration Mode* changes to 0 if the procedure was successful or 255 if it failed. During the procedure, write parameter *Calibration Mode* is ignored.



- In order to detect whether execution has been successful, make sure to let your program monitor the value of read parameter Calibration Mode while the zeroing procedure is running. Once it has finished, write parameter Calibration Mode is accepted again, so it is immediately overwritten.*
- After performing the procedure, remember to set parameter Initreset to value 82 to lock secured parameters.*



## 6 Digital communication

### 6.1 RS-232 communication

Digital Bronkhorst® instruments can be monitored and operated via RS-232 using the free **FlowWare** software tools for Windows. These tools provide a graphical interface to the [ProPar](#) protocol, for monitoring and editing parameter values.

The FlowWare toolkit provides functionality for monitoring and operating digital instruments (Bronkhorst FlowSuite, FlowPlot), selection of the active fluid and configuration of the fieldbus connection (if applicable). For instruments that support the definition and use of multiple fluids FlowTune™ can be used to store fluid definitions in the instrument and select the active fluid.

Digital instrument parameters are made accessible by **FlowDDE**, a Dynamic Data Exchange server (DDE) that handles communication between the instrument and (dedicated) client software in Windows (e.g. FlowPlot). FlowDDE can also be used by other client applications, such as Microsoft Office or custom made software, built with third party development software like LabVIEW or a SCADA platform.



The FlowWare tools and associated documentation can be downloaded from the product pages on the Bronkhorst website: [www.bronkhorst.com/products](http://www.bronkhorst.com/products)



- If the power and signal connector is set for RS-485 communication, the instrument will not respond to an RS-232 master. In that case, use the [multifunctional switch](#) to enter configuration mode and enable RS-232 communication.
- After configuring the required parameters, follow the same procedure to leave configuration mode and restore the original communication settings (otherwise, configuration mode will remain enabled after the next power-up).



For more information about communication through the RS-232 interface, consult the [RS-232 manual](#).

### 6.2 Fieldbus communication



Not all parameters described in this document are necessarily available with all digital interface types. For information about parameter access and availability for Bronkhorst® instruments in a specific fieldbus network, consult the according [fieldbus manual](#).

### 6.3 Parameters



A summary of all digital parameters in this section can be found in the back of this manual.

This section describes the most commonly used parameters for digital operation of the ES-FLOW™. Descriptions are grouped by category in tables as shown below:

Type	Access	Range	FlowDDE	FLOW-BUS	Modbus
[type]	RW	[x]...[y]	[DDE par]	[Pro]/[Par]	[address]/[register]



In this manual, parameter names are printed in italics (reverted to normal where embedded in italics, like in this tip).

#### Type

Unsigned char	1 byte unsigned integer (0...255)
Unsigned int	2 byte unsigned integer, MSB first (0...65535)
Unsigned long	4 byte unsigned integer, MSB first (0...4294967295)
Float	4 byte floating point, IEEE 32-bit single precision, MSB first
Unsigned char [x]	x byte text string

#### Access

R	Parameter value can be read
W	Parameter value can be written
	Parameter is secured and only accepts values if parameter <i>Init Reset</i> is set to 'unlocked' first

**Range**

Some parameters only accept values within a certain range:

[x]                    Minimum value  
[y]                    Maximum value

**FlowDDE**

Parameter number within FlowDDE

**FLOW-BUS**

FLOW-BUS uses the ProPar protocol, where parameters are identified by a unique combination of a process number and a parameter number.



- For more information about setting up a FLOW-BUS network with Bronkhorst® instruments, consult the FLOW-BUS manual (see [Documentation](#)).
- For more information about the ProPar protocol, consult the RS-232 manual (see [Documentation](#)).

**Modbus**

In the Modbus protocol, parameters are accessed by specifying their unique decimal register number or corresponding PDU address (Protocol Data Unit). The PDU address is the hexadecimal translation of the register number minus 1, e.g. register number 1 corresponds to PDU address 0x0000, register number 11 corresponds to PDU address 0x000A:

[address]            Hexadecimal PDU address  
[register]            Decimal register number

Modbus address blocks are two bytes big. Larger data types use up to 8 subsequent address blocks, resulting in a maximum variable length of 16 bytes. Values longer than the maximum length are truncated.



For more detailed information about setting up a Modbus network with Bronkhorst® instruments, consult the Modbus manual (see [Documentation](#)).

**Other interface protocols**

Parameter descriptions in this document are based on their availability with FLOW-BUS, Modbus or RS-232 (ProPar) communication. Due to limitations in, for example, memory capacity or communication properties, definition files for other fieldbus systems usually do not make all parameters available.



Not all parameters described in this document are necessarily available with all digital interface types. For information about parameter access and availability for Bronkhorst® instruments in a specific fieldbus network, consult the according [fieldbus manual](#).

**6.3.1 Measurement and control****Measure**

Type	Access	Range	FlowDDE	FLOW-BUS	Modbus
Unsigned int	R	0...41942 (65535*)	8	1/0	0x0020/33

This parameter returns a dimensionless representation of the measured flow rate or pressure. The value 32000 corresponds to 100 %, the maximum value corresponds to 131.07 %.



\*In case the instrument is prepared for bi-directional measurement, the negative signals with an output range of -73.73...-0.003% are represented by the range of 41943...65535, whereas the positive signals 0...131.07% are still represented by the range of 0...41942. (FlowDDE converts the numbers to negative values automatically).

**Setpoint**

Type	Access	Range	FlowDDE	FLOW-BUS	Modbus
Unsigned int	RW	0...32000	9	1/1	0x0021/34

This parameter is a dimensionless representation of the required flow rate or pressure. Value 32000 corresponds to 100 %.

### 6.3.1.1 Advanced measurement and control

#### fMeasure

Type	Access	Range	FlowDDE	FLOW-BUS	Modbus
Float	R	-3.4E+38... 3.4E+38	205	33/0	0xA100...0xA101/ 41217...41218

This parameter represents the value of parameter *Measure*, expressed in the selected *Capacity Unit*. Its value is calculated from the dimensionless value of *Measure*, using the fluid set parameters *Capacity 100%* and *Capacity Unit*.

#### Fsetpoint

Type	Access	Range	FlowDDE	FLOW-BUS	Modbus
Float	RW	0...3.4E+38	206	33/3	0xA118...0xA119/ 41241...41242

This parameter represents the value of parameter *Setpoint*, expressed in the selected *Capacity Unit*. Conversion between *Fsetpoint* and the dimensionless value of *Setpoint* uses fluid set parameters *Capacity 100%* and *Capacity Unit*.

#### Setpoint Slope

Type	Access	Range	FlowDDE	FLOW-BUS	Modbus
Unsigned int	RW	0...30000	10	1/2	0x0022/35

The value of this parameter represents the time it would take to adjust the setpoint if it were changed from 0 to 100 %. This feature can be used to smooth 'nervous' controller behavior, e.g. to reduce setpoint overshoot or undershoot. The supported range corresponds to 0...3000 seconds. Default value = 0.

Example:

If *Setpoint Slope* = 100 it will take 10 seconds to adjust the setpoint if it is changed from 0 to 100%. A setpoint change of 20% will take  $(20\%/100\%)*10$  seconds = 2 seconds.

#### Analog Input

Type	Access	Range	FlowDDE	FLOW-BUS	Modbus
Unsigned int	R	0...65535	11	1/3	0x0023/36

This parameter contains a digital translation of the analog input signal (if applicable).

#### Valve Output

Type	Access	Range	FlowDDE	FLOW-BUS	Modbus
Unsigned long	RW	0... 16777215	55	114/1	0xF208...0xF209/61961...61962

This parameter represents the controller output signal for control valve operation.

### 6.3.1.2 Secondary outputs

#### Temperature

Type	Access	Range	FlowDDE	FLOW-BUS	Modbus
Float	R	-250...500	142	33/7	0xA138...0xA139/41273...41274

This parameter returns the internal temperature in the instrument housing in °C.

### 6.3.2 Alarms



Alarm settings are most easily accessible using Bronkhorst FlowSuite, FlowPlot or FlowView or a Bronkhorst® readout and control unit.

The built-in alarm functionality can be used to handle different alarm types:

- system errors and warnings
- min/max alarms
- response alarms
- batch alarms
- master/slave alarms

The alarm type can be set with parameter *Alarm Mode*. When an alarm is activated, the type can be read out using parameter *Alarm Info*. An automatic setpoint change can be set using the parameters *Alarm Setpoint Mode* and *Alarm New Setpoint*. It is also possible to set an alarm delay, to prevent overreaction to small disturbances, using parameter *Alarm Delay Time*. The methods by which an alarm can be reset are controlled by *Reset Alarm Enable*.

#### Alarm Mode

Type	Access	Range	FlowDDE	FLOW-BUS	Modbus
Unsigned char	RW	0...3	118	97/3	0x0C23/3108

Available modes:

Value	Description
0	Alarm off
1	Alarm on absolute limits
2	Alarm on limits related to setpoint (response alarm)
3	Alarm at power-up(e.g. after power-down)

(On DeviceNet™ instruments, only modes 0 and 1 are available)

#### Alarm Info

Type	Access	Range	FlowDDE	FLOW-BUS	Modbus
Unsigned char	R	0...255	28	1/20	0x0034/53

This parameter provides information about the event type(s) that triggered an alarm situation. The value is a bitwise summation of the issued alarm types; convert the value to binary to see which types are issued. The following alarm types can be issued:

Bit	Value	Type	Description
0	1	Error	Error flag raised
1	2	Warning	Warning flag raised
2	4	Minimum alarm	<i>Measure</i> < <i>Alarm minimum limit</i>
3	8	Maximum alarm	<i>Measure</i> > <i>Alarm maximum limit</i>
4	16	Batch counter alarm	Batch counter reached its limit
5	32	<ul style="list-style-type: none"> <li>• This bit only: Power-up alarm</li> <li>• If combined with bit 2 or 3: Response alarm</li> </ul>	Alarm possibly caused by a power dip Difference between <i>Measure</i> and <i>Setpoint</i> too big
6	64	Master/slave alarm	Setpoint out of limits (caused by <i>Slave factor</i> )
7	128	Hardware alarm	Hardware error

#### Alarm Delay Time

Type	Access	Range	FlowDDE	FLOW-BUS	Modbus
Unsigned char	RW	0...255	182	97/7	0x0C27/3112

This value represents the time in seconds the alarm action will be delayed when an alarm limit has been exceeded. This value also delays the alarm off action if an alarm limit is no longer exceeded.  
Default value = 0.

**Alarm Maximum Limit**

Type	Access	Range	FlowDDE	FLOW-BUS	Modbus
Unsigned int	RW	0...32000	116	97/1	0x0C21/3106

Maximum limit for *Measure* to activate the maximum alarm situation (after *Alarm Delay Time*). Range 0...32000 represents 0...100% signal. *Alarm Maximum Limit* must be greater than *Alarm Minimum Limit*.  
Default value: 0.

**Alarm Minimum Limit**

Type	Access	Range	FlowDDE	FLOW-BUS	Modbus
Unsigned int	RW	0...32000	117	97/2	0x0C22/3107

Minimum limit for *Measure* to activate the minimum alarm situation (after *Alarm Delay Time*). Range 0...32000 represents 0...100% signal. *Alarm Minimum Limit* must be smaller than *Alarm Maximum Limit*.  
Default value: 0.

**Alarm Setpoint Mode**

Type	Access	Range	FlowDDE	FLOW-BUS	Modbus
Unsigned char	RW	0...1	120	97/5	0x0C25/3110

Specifies whether or not to change the setpoint after an alarm situation is activated.

Value	Description
0	No setpoint change (default)
1	Change setpoint to <i>Alarm new setpoint</i>

**Alarm New Setpoint**

Type	Access	Range	FlowDDE	FLOW-BUS	Modbus
Unsigned int	RW	0...32000	121	97/6	0x0C26/3111

New (safe) setpoint during an alarm until reset. Range 0...32000 represents 0...100% setpoint.  
Default value: 0

**Reset Alarm Enable**

Type	Access	Range	FlowDDE	FLOW-BUS	Modbus
Unsigned char	RW	0...15	156	97/9	0x0C29/3114

Available reset methods. The value is a bitwise summation of the enabled methods; convert the value to binary to see which methods are enabled.  
Default value: 15 (all bits/methods enabled)

The following methods are supported:

Bit	Value	Description
0	1	By hardware switch (if present)
1	2	Externally (obsolete)
2	4	By parameter <i>Reset</i>
3	8	Automatically (when alarm conditions no longer apply)

### 6.3.3 Counter



- Counter settings are most easily accessible using Bronkhorst FlowSuite, FlowPlot or FlowView or a Bronkhorst® readout and control unit.
- When the instrument is powered down, it remembers the state of the counter. If the counter is active when the instrument is powered down, it is activated when powered up and then continues to count from the value at the time of power down.

#### Counter Mode

Type	Access	Range	FlowDDE	FLOW-BUS	Modbus
Unsigned char	RW	0...2	130	104/8	0x0D08/3337

Available modes:

Value	Description
0	Counter off (default)
1	Counting up continuously
2	Counting up until limit reached (set by <i>Counter Limit</i> )

#### Counter Unit

Type	Access	Range	FlowDDE	FLOW-BUS	Modbus
Unsigned char[4]	RW	see table below	128	104/7	0xE838...0xE839/59449...59450

This parameter contains the name of the counter readout unit.

*Counter Unit* supports the following values:

Mass	Normal volume (1.01325 bar(a), 0 °C)	Standard volume (1.01325 bar(a), 20 °C)	Custom volume (Capacity Unit Pressure, Capacity Unit Type Temperature)
ug, mg, g, kg	uln, mln, ln, mm3n, cm3n, dm3n, m3n	uls, mls, ls, mm3s, cm3s, dm3s, m3s	ul, ml, l, mm3, cm3, dm3, m3



Parameter Density (FlowDDE ID 170) is used to calculate Custom volume.

#### Counter Value

Type	Access	Range	FlowDDE	FLOW-BUS	Modbus
Float	RW	0... 10000000	122	104/1	0xE808...0xE809/59401...59402

Current counter value in units selected with parameter *Counter Unit*.

#### Counter Limit

Type	Access	Range	FlowDDE	FLOW-BUS	Modbus
Float	RW	0...9999999	124	104/3	0xE818...0xE819/59417...59418

Counter limit/batch size in units selected with parameter *Counter Unit*.

Default value: 0.

**Counter Setpoint Mode**

Type	Access	Range	FlowDDE	FLOW-BUS	Modbus
Unsigned char	RW	0...1	126	104/5	0x0D05/3334

Specifies whether or not to change the setpoint after reaching the counter limit.

Value	Description
0	No setpoint change (default)
1	Change setpoint to <i>Counter new setpoint</i>

**Counter New Setpoint**

Type	Access	Range	FlowDDE	FLOW-BUS	Modbus
Unsigned int	RW	0...32000	127	104/6	0x0D06/3335

New (safe) setpoint when a counter limit is reached until reset. Range 0...32000 represents 0...100% setpoint. Default value: 0

**Reset Counter Enable**

Type	Access	Range	FlowDDE	FLOW-BUS	Modbus
Unsigned char	RW	0...15	157	104/9	0x0D09/3338

Available reset methods. The value is a bitwise summation of the enabled reset methods; convert the value to binary to see which methods are enabled.

Default value: 7 (bits/methods 0, 1 and 2 enabled)

The following methods are supported:

Bit	Value	Description
0	1	By hardware switch (if present)
1	2	Externally (obsolete)
2	4	By parameter <i>Reset</i>
3	8	Automatically (e.g. when counter value is reset)

**6.3.4 Network configuration**

Changes made to the network settings will **not** be restored by a factory reset.

**Default configuration**

Network configuration is done ex factory as ordered. The table below shows the supported configurations for the available interface protocols (default settings are printed in bold):

Protocol	ProPar (RS-232)	FLOW-BUS (RS-485)	Modbus (RTU/ASCII)	PROFIBUS DP	CANopen	DeviceNet™
Address	<b>3</b>	<b>3...125</b>	<b>1...247</b>	<b>0...126</b>	<b>1...127</b>	<b>0...63</b>
Baud Rate	9600 19200 <b>38400</b> 57600 115200 230400 460800	<b>187500</b> 400000	9600 <b>19200</b> 38400 56000 57600 115200 128000 256000	<b>(autodetect)</b> 9600 19200 45450 93750 187500 500000 1500000 3000000 6000000 12000000	10000 20000 50000 125000 250000 <b>500000</b> 800000 1000000	<b>125000</b> 250000 500000
Parity	<b>0</b>	<b>0</b>	0, 1, 2	<b>2</b>	<b>0</b>	<b>0</b>

Network configuration for Ethernet based fieldbus types is done automatically via the Ethernet protocol.

**Communication via fieldbus connector (RS-485)**

Use the following parameters to configure the instrument for communication through the fieldbus connector (5-pin M12):

**Fieldbus1 Address**

Type	Access	Range	FlowDDE	FLOW-BUS	Modbus
Unsigned char	RW 	0...255	199	125/10	0x0FAA/4011

**Fieldbus1 Baud Rate**

Type	Access	Range	FlowDDE	FLOW-BUS	Modbus
Unsigned long	RW 	0...1.0E10	201	125/9	0xFD48...0xFD49/64841...64842

**Fieldbus1 Parity**

Type	Access	Range	FlowDDE	FLOW-BUS	Modbus
Unsigned char	RW 	0...2	335	125/12	0xFAC/4013

The following values are supported:

Value	Description
0	No parity
1	Odd parity
2	Even parity

**Communication via standard connector (RS-232/RS-485)**

Use the following parameters to configure the instrument for communication through the 8-pin M12 connector:



- If the power and signal connector is set for RS-485 communication, the instrument will not respond to an RS-232 master. In that case, use the [multifunctional switch](#) to enter configuration mode and enable RS-232 communication.
- After configuring the required parameters, follow the same procedure to leave configuration mode and restore the original communication settings (otherwise, configuration mode will remain enabled after the next power-up).

**Fieldbus2 Address**

Type	Access	Range	FlowDDE	FLOW-BUS	Modbus
Unsigned char	RW 	0...255	309	124/10	0x0F8A/3979

**Fieldbus2 Baud Rate**

Type	Access	Range	FlowDDE	FLOW-BUS	Modbus
Unsigned long	RW 	0...1.0E10	310	124/9	0xFC48...0xFC49/64585...64586

**Fieldbus2 Parity**

Type	Access	Range	FlowDDE	FLOW-BUS	Modbus
Unsigned char	RW 	0...2	336	124/12	0xF8C/3981

The following values are supported:

Value	Description
0	No parity
1	Odd parity
2	Even parity



### 6.3.5 Fluid

#### Fluid Name

Type	Access	Range	FlowDDE	FLOW-BUS	Modbus
Unsigned char[10]	RW 	-	25	1/17	0x8188...0x818C/33161...33165

This parameter contains the name of the process fluid.

#### Capacity 100%

Type	Access	Range	FlowDDE	FLOW-BUS	Modbus
Float	RW 	1E-10... 1E+10	21	1/13	0x8168...0x8169/33129...33130

This parameter represents the 100 % readout/control value (span), expressed in the selected *Capacity Unit*.

#### Capacity Unit

Type	Access	Range	FlowDDE	FLOW-BUS	Modbus
Unsigned char[7]	RW 	see below	129	1/31	0x81F8...0x81FB/33273...33276

This parameter represents the unit in which *Capacity 100%* is expressed.

Available units:

Mass flow	Normal volume flow (1.01325 bar(a), 0 °C)	Standard volume flow (1.01325 bar(a), 20 °C)	Custom volume flow ( <i>Capacity Unit Type Pressure</i> , <i>Capacity Unit Type Temperature</i> )
ug/h, ug/min, ug/s, mg/h, mg/min, mg/s, g/h, g/min, g/s, kg/h, kg/min, kg/s	uln/h, uln/min, uln/s, mln/h, mln/min, mln/s, ln/h, ln/min, ln/s, ccn/h, ccn/min, ccn/s, mm3n/h, mm3n/m, mm3n/s, cm3n/h, cm3n/m, cm3n/s, m3n/h, m3n/min, m3n/s, scfh, scfm, scfs, sccm, slm	uls/h, uls/min, uls/s, mls/h, mls/min, mls/s, ls/h, ls/min, ls/s, ccs/h, ccs/min, ccs/s, mm3s/h, mm3s/m, mm3s/s, cm3s/h, cm3s/m, cm3s/s, m3s/h, m3s/min, m3s/s	ul/h, ul/min, ul/s, ml/h, ml/min, ml/s, l/h, l/min, l/s, cc/h, cc/min, cc/s, mm3/h, mm3/m, mm3/s, cm3/h, cm3/m, cm3/s, m3/h, m3/min, m3/s, cfh, cfm, cfs



Because of the maximum string length of 7 characters, some unit names are abbreviated, for instance mm3n/m means mm<sup>3</sup>n/min.

#### Speed of Sound (Special parameter f1 float)

Type	Access	Range	FlowDDE	FLOW-BUS	Modbus
Float	R	1E-10... 1E+10	373	127/9	0xFF48...0xFF49/65353...62354

This parameter returns the traveling speed of sound in meters per second through the metered fluid, measured by the instrument.

### 6.3.6 Controller

The picture below is a simplified visualization of the PID controller algorithm (proportional, integral, derivative) used by digital Bronkhorst® instruments.

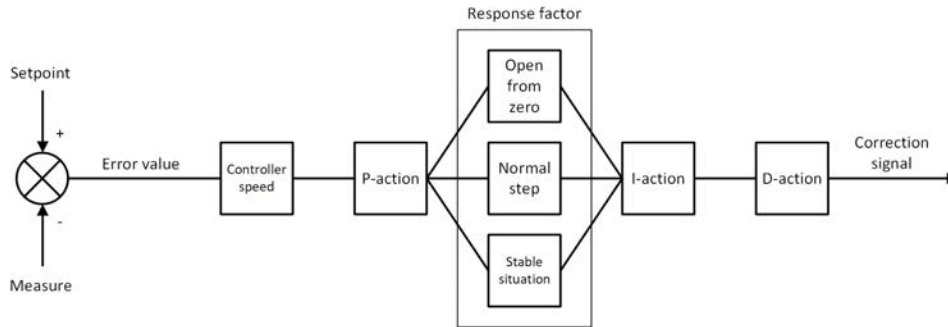

The controller speed controls the overall performance of the controller algorithm. Basically, to adjust the controller response, only the controller speed needs to be changed.

The algorithm is based upon the difference between the setpoint and the measured value (called the error value). The correction signal to eliminate the error is assembled from 3 components (giving the algorithm its name):

- The P-action (proportional) multiplies the error value by a constant factor, to adjust the measure towards the (new) setpoint.
- The I-action (integral) amplifies the correction signal with a factor depending on the integral of the error value over time.
- The D-action (derivative) reduces the strength of the P-action, to prevent overshoot when the (new) setpoint is reached.

The proportional action is enhanced by one of three additional response factors, depending on the control cycle stage:

- Open from zero: the setpoint is larger than zero and the measured value is below 2% of the full scale range.
- Normal step: the measured value differs more than 2% from the setpoint, typically after changing the setpoint (step).
- Stable situation: the measured value differs less than 2% from the setpoint.



Control characteristics are optimized during production. These parameters should only be changed if absolutely necessary, and only by or under the supervision of trained service personnel.

#### Controller Speed

Type	Access	Range	FlowDDE	FLOW-BUS	Modbus
Float	RW	0.2...5	254	114/30	0xF2F0...0xF2F1/62193...62194

This parameter sets the overall controller speed factor for the selected fluid. *Controller speed* is set ex factory between value '0.5' (slow) and '2' (fast). The default value is '1'.

#### PID-Kp

Type	Access	Range	FlowDDE	FLOW-BUS	Modbus
Float	RW	0...1E+10	167	114/21	0xF2A8...0xF2A9/62121...62122

PID controller proportional action, multiplication factor.

#### PID-Ti

Type	Access	Range	FlowDDE	FLOW-BUS	Modbus
Float	RW	0...1E+10	168	114/22	0xF2B0...0xF2B1/62129...62130

PID controller integral action in seconds.

**PID-Td**

Type	Access	Range	FlowDDE	FLOW-BUS	Modbus
Float	RW 	0...1E+10	169	114/23	0xF2B8...0xF2B9/62137...62138

PID controller derivative action in seconds. The default value is 0.0.

**Open From Zero Response**

Type	Access	Range	FlowDDE	FLOW-BUS	Modbus
Unsigned char	RW 	0...255	165	114/18	0x0E52/3667

Response factor, applied to proportional action when opening the valve from 0%.

- Default value: 128 (no correction)
- Other values adjust the controller gain (correction signal) as follows:  $\text{Controller gain} = \text{Controller Speed} * \text{PID-Kp} * 1.05^{(\text{response factor} - 128)}$

**Normal Step Response**

Type	Access	Range	FlowDDE	FLOW-BUS	Modbus
Unsigned char	RW 	0...255	72	114/5	0x0E45/3654

Response factor, applied to proportional action during normal control (at setpoint step).

- Default value: 128 (no correction)
- Other values adjust the controller gain (correction signal) as follows:  $\text{Controller gain} = \text{Controller Speed} * \text{PID-Kp} * 1.05^{(\text{response factor} - 128)}$

**Stable Situation Response**

Type	Access	Range	FlowDDE	FLOW-BUS	Modbus
Unsigned char	RW 	0...255	141	114/17	0x0E51/3666

Stable situation response, applied when the controller is stable (within a 2% band around the setpoint).

- Default value: 128 (no correction)
- Other values adjust the controller gain (correction signal) as follows:  $\text{Controller gain} = \text{Controller Speed} * \text{PID-Kp} * 1.05^{(\text{response factor} - 128)}$

**6.3.7 Master/slave configuration (FLOW-BUS)**

Normally, there is no communication between the instruments in a fieldbus system. The FLOW-BUS protocol, however, provides a feature to set up a master/slave relationship between two instruments. The typical behavior of a slave instrument is to automatically set its own setpoint relative to the output (measurement value) of its master.

The output value of any instrument in a FLOW-BUS network is automatically available to all other instruments without extra wiring. A slave instrument can also be a master to other instruments.

To set up a master/slave relationship between instruments, set parameter *Control Mode* of the slave instrument to 'FLOW-BUS slave' (value 2) or 'FLOW-BUS analog slave' (value 13), depending on how the setpoint should be calculated.

The slave instrument polls the output value of its master periodically and uses the slave factor to set its own setpoint relative to the master's.



To prevent damage to the instruments an/or the system(s) they are connected to, be sure to avoid circular references between devices on the same fieldbus. The FLOW-BUS system does not have a protection mechanism.

**Master Node**

Type	Access	Range	FlowDDE	FLOW-BUS	Modbus
Unsigned char	RW	1...128	158	33/14	n/a

Sets the master node for the instrument.

Note that this parameter is only effective in a FLOW-BUS network (RS-485).

**Slave Factor**

Type	Access	Range	FlowDDE	FLOW-BUS	Modbus
Float	RW	0...500	139	33/1	0xA108...0xA109/41225...41226

The controller output from the master instrument is multiplied by *Slave Factor*/100 % to get the slave instrument setpoint. In systems other than FLOW-BUS, *Slave Factor* is effective only if *Control Mode* is set to 'Analog slave', and the analog output signal of the master instrument is redirected to the input of the slave instrument.

Example:

- master output = 80 %
  - *Slave Factor* = 50
- ⇒ slave instrument setpoint = 80 % x 50 %/100 % = 40 %

**6.3.8 Device identification****User Tag**

Type	Access	Range	FlowDDE	FLOW-BUS	Modbus
Unsigned char[16]	RW	-	115	113/6	0xF130...0xF137/ 61745...61752

With this parameter, the instrument can be given a custom tag name, with a maximum of 16 characters.

**Customer Model**

Type	Access	Range	FlowDDE	FLOW-BUS	Modbus
Unsigned char[16]	RW 	-	93	113/4	0xF120...0xF127/ 61729...61736

This parameter is used to add extra information to the model number information, such as a customer-specific model number.

**Serial Number**

Type	Access	Range	FlowDDE	FLOW-BUS	Modbus
Unsigned char[20]	R	-	92	113/3	0xF118...0xF11F/ 61721...61728

Instrument serial number for identification.

**BHT Model Number**

Type	Access	Range	FlowDDE	FLOW-BUS	Modbus
Unsigned char[35]	RW 	-	91	113/2	0xF110...0xF117/ 61713...61720

This parameter shows the Bronkhorst® instrument model type information.

**Firmware Version**

Type	Access	Range	FlowDDE	FLOW-BUS	Modbus
Unsigned char[6]	R	-	105	113/5	0xF128...0xF12A/ 61737...61739

Revision number of the firmware

**Identification Number**

Type	Access	Range	FlowDDE	FLOW-BUS	Modbus
Unsigned char	RW 	0...255	175	113/12	0x0E2C/3629

Bronkhorst® (digital) device type identification number.

**Device Type**

Type	Access	Range	FlowDDE	FLOW-BUS	Modbus
Unsigned char[6]	R	-	90	113/1	0xF108...0xF10A/ 61705...61707

Device type information string; this parameter contains an abbreviation referring to the identification number.

**6.3.9 Special parameters****Init Reset**

Type	Access	Range	FlowDDE	FLOW-BUS	Modbus
Unsigned char	RW	82/64	7	0/10	0x000A/11

*Init Reset* is used to unlock secured parameters (marked with a  symbol) for writing. It supports the following values:

Value	Description
64	unlocked, secured parameters can be read and written to
82	locked, secured parameters are read-only

At power-up, *Init Reset* is always set to 'Locked' (value 82).

**Reset**

Type	Access	Range	FlowDDE	FLOW-BUS	Modbus
Unsigned char	R	0...7	114	115/8	0x0E68/3689

This parameter is used to reset the program, counter or alarms.

Value	Description
0	No reset
1	Reset counter
2	Reset alarm
3	Reset counter
4	Reset and disable counter
5	Reset firmware program (soft reset)
6	Reset <i>Alarm info</i> error bit
7	Reset <i>Alarm info</i> warning bit



*The Reset parameter may be disabled by Reset Alarm Enable or Reset Counter Enable. Make sure the value is accepted by sending value 0 first.*

**Wink**

Type	Access	Range	FlowDDE	FLOW-BUS	Modbus
Unsigned char [27]	W	0...9*	1	0/0	0x0000/1

Sending any text string value between 1 and 9 to this parameter makes the indication LEDs (if present) blink for a couple of seconds. This can be useful in order to identify a specific device in a large fieldbus network.

\*) Modbus only supports value 14592

**Control Mode**

Type	Access	Range	FlowDDE	FLOW-BUS	Modbus
Unsigned char	RW	0...255	12	115/1	0x0024/37

*Control Mode* is used to select different control modes of the instrument and determines from which source(s) it accepts a setpoint.

The following modes are available:

Value	List option	Description	Setpoint source
0	Bus/RS232	Normal digital operation	Fieldbus or RS-232
1	Analog input	Normal analog operation	Analog input
2	FLOW-BUS slave	Acting as slave instrument on FLOW-BUS	FLOW-BUS master
3	Valve close	Controller disabled, valve closed	
4	Controller idle	Controller disabled, valve frozen in current position	
7	Setpoint 100%	Setpoint fixed at 100 %	
8	Valve fully open	Controller disabled, valve fully open	
9	Calibration mode	Calibration mode enabled	
10	Analog slave	Acting as slave of other instrument in analog mode	Analog input
12	Setpoint 0%	Setpoint fixed at 0%	
13	FLOW-BUS analog slave	Acting as slave of other instrument on FLOW-BUS, slave factor set by analog input signal	Analog input
18	RS232	Controlling, <a href="#">default/safe state</a> disabled	Fieldbus or RS-232
20	Valve steering	Controller disabled, setpoint redirected to <i>Valve Output</i>	
21	Analog valve steering	Controller disabled, analog input redirected to <i>Valve Output</i>	
22	Valve safe state	Instrument in <a href="#">default/safe state</a>	

- Default value: 0 or 1 (as ordered).
- If *Control Mode* is changed to value 0, 1, 9 or 18, the instrument returns to the default value at the next power-up or reset. Other values are persistent.
- *Control Mode* 18 prevents the instrument from assuming its [default/safe state](#) in the event of a digital communication failure.
- The column labeled *List option* shows the control modes as used in Bronkhorst® software.

#### Calibration Mode

Type	Access	Range	FlowDDE	FLOW-BUS	Modbus
Unsigned char	RW 	0, 9, 255	58	1/4	0x0E61/3682

After enabling calibration mode by means of parameter *Control Mode*, this parameter is used to start the autozero function of the flow sensor. The following modes are supported:

Value	Description
0	Idle (no action)
9	Start zeroing
255	Error (result of previous calibration mode)

#### 6.3.9.1 Default control mode

##### IO Status

Type	Access	Range	FlowDDE	FLOW-BUS	Modbus
Unsigned char	RW 	0...255	86	114/11	0x0E4B/3660

The instrument is set to accept a setpoint from either an analog or a digital source. Although this setting can be changed with parameter [Control Mode](#), the instrument usually returns to its default control mode at every power-up or reset. The default control mode can be set with parameter *IO Status*; to change it, use the procedures as described below.

Changing from digital operation to analog operation:

1. Set parameter *Init Reset* to 64 (unlocked)
2. Read parameter *IO Status*
3. Add 64 to the read value
4. Write the new value to parameter *IO Status*
5. Set parameter *Init Reset* to 82 (locked)

Changing from analog operation to digital operation:

1. Set parameter *Init Reset* to 64 (unlocked)
2. Read parameter *IO Status*
3. Subtract 64 from the read value
4. Write the new value to parameter *IO Status*
5. Set parameter *Init Reset* to 82 (locked)



*The procedures described above do not change the value of parameter Control Mode. To apply the new default control mode, reset or restart the instrument.*

## 7 Maintenance



*Inexpertly servicing instruments can lead to serious personal injury and/or damage to the instrument or the system it is used in. Servicing must therefore be performed by trained and qualified personnel. Contact your Bronkhorst representative for information about cleaning and calibration. Bronkhorst has trained staff available.*



- *Before disconnecting or disassembling any fluid system related parts, always make sure the fluid system is depressurized to atmospheric pressure.*
- *When depressurizing, prevent sudden pressure changes by shutting off the fluid supply gradually.*

In order to prevent clogging and maintain functionality and the specified performance, flushing the fluid system with an appropriate (cleaning) fluid is advised at the following occasions:

- before changing fluid types
- before and after using corrosive, reactive or flammable media
- before and after prolonged shutdown periods\*
- every 3 months

In the event of serious contamination, flushing the fluid system may even be necessary to restore the specified system performance.

\*) As a rule of thumb a period of a few days to a week can be assumed. In practice, the length of this period strongly depends on the properties of the processed medium and the ambient and process conditions. With some media, leaving the installation unused for longer periods of time without flushing will be no problem, while other fluids will already cause trouble after a very short time of inactivity.



*Always use a non-aggressive, non-corrosive cleaning liquid or a dry, inert gas (like Nitrogen or Argon) to flush the fluid system.*

Although the ES-FLOW™ has been tested thoroughly at the factory for leaks in the fluid system, environmental influences (such as excessive vibrations and temperature and humidity fluctuations) can cause wear to tubing, piping and fluid connections over time.



*Frequent inspection of all fluid lines and connections before, during and after operation is essential, to ensure and maintain a safe working environment. If necessary, re-tighten fluid connections.*

### 7.1 Cleaning



*When the measuring tube gets clogged by highly viscous and/or sticky liquids, it can be cleaned manually, using a thin channel cleaning brush before flushing it with a cleaning liquid.*



*The end user is responsible for validation of the cleaning procedure and results.*

### 7.2 Calibration

The ES-FLOW™ has been factory calibrated. Periodical inspection, recalibration or verification of the accuracy may be subject to individual requirements of the user. Whenever necessary, contact your Bronkhorst representative for information and/or making arrangements for recalibration.

Bronkhorst certifies that the instrument meets the rated accuracy. Calibration has been performed using measurement standards traceable to the Dutch Metrology Institute (VSL).



## 8 Troubleshooting and service

### Errors and warnings



- Most other indications are specific to the installed communication interface; consult the according [interface manual](#) for a list of all indications.
- Detailed error and warning information can also be found by connecting the instrument to FlowDDE and FlowPlot. FlowDDE puts all errors and warnings on the console screen; FlowPlot provides several specific alarm and counter indicators.

### General problems



- Electronic problems can be traced by restarting the equipment.
- If the equipment starts up normally, the measurement and control behavior can be checked by applying fluid pressure.
- To track down problems in the fluid system, depressurize the fluid system and disconnect the suspected unit from the process line. Dirt or clogging might be quickly detected by visual inspection of disassembled fluid connections.



If you suspect leakage, do not disassemble the device for inspection, but contact your Bronkhorst representative for service or repairs.

### 8.1 LED indications

- (green) Mode/MOD: operation mode indication
- (red) Error/NET: error/warning messages

The tables below list the different LED indications:

● Green		
Pattern	Time	Indication
off	continuous	Power-off or program not running
on	continuous	Normal operation mode
short flash	0.1 sec on, 2 sec off	No bus communication, valves are in safe state
blink	0.2 sec on, 0.2 sec off	Special function mode; the instrument is busy performing a special function (e.g. auto-zero or self-test)
long flash	2 sec on, 0.1 sec off	Configuration mode; on the 5-pin M12 connector, the baud rate is set to 38400 and the bus type to RS-232 FLOW-BUS (ProPar)

● Red		
Pattern	Time	Indication
off	continuous	No error
on	continuous	No liquid in measuring tube <b>OR</b> Pulsating flow rate <b>OR</b> Critical error; the instrument needs servicing before it can be used
short flash	0.1 sec on, 2 sec off	<b>FLOW-BUS</b> Node occupied: re-install instrument <b>PROFIBUS DP</b> No data exchange between master and slave (automatic recovery) <b>Modbus</b> Data is being received or transmitted
blink	0.2 sec on, 0.2 sec off	<b>FLOW-BUS</b> Waiting for communication, check communication settings of all FLOW-BUS devices in the fieldbus setup. Usually the 'last node address' setting of one of the devices is incorrect. <b>PROFIBUS DP</b> Not used <b>Modbus</b> Not used
long flash	2 sec on, 0.1 sec off	<b>FLOW-BUS</b> Not used <b>PROFIBUS DP</b> Requested parameter not available <b>Modbus</b> Not used

● Green and ● red (alternating)		
Pattern	Time	Indication
slow wink	1 sec on, 1 sec off	Alarm indication; minimum/maximum alarm, power-up alarm, limit reached or batch size reached
normal wink	0.2 sec on, 0.2 sec off	Wink mode; by sending a command to the <i>Wink</i> parameter, the instrument flashes its LEDs, so that it can be located in the physical setup
fast wink	0.1 sec on, 0.1 sec off	Selected action started (after releasing the multifunctional switch)

## 8.2 Common issues

Symptom	Possible cause	Corrective action
No communication	No power supply	<ul style="list-style-type: none"> <li>• Check power supply</li> <li>• Check cable connection</li> <li>• Check cable hook-up</li> </ul>
	Invalid node address	Change node address (see <a href="#">Network configuration</a> )
	Invalid baud rate	Make sure instrument baud rate matches master/application baud rate
	Other	Reset instrument and/or restart master. If problem persists, contact your Bronkhorst representative
No output signal	No power supply	<ul style="list-style-type: none"> <li>• Check power supply</li> <li>• Check cable connection</li> <li>• Check cable hook-up</li> </ul>
	Invalid control mode (instrument accepts no setpoint)	Check control mode (see <a href="#">Special parameters</a> )
	No setpoint given or setpoint too low	Give setpoint $\geq 2\%$
	Valve(s) in default state (normally closed)	Check if valves are in default state; solve cause if necessary (see <a href="#">Default valve state</a> )
	Upstream pressure too low	Increase upstream pressure (to a value within specifications)
	Downstream pressure too high	Decrease downstream pressure (to a value within specifications)
	Differential pressure too low	Make sure differential pressure is within specifications
	<ul style="list-style-type: none"> <li>• Fluid system clogged or blocked</li> <li>• Sensor obstructed or contaminated</li> </ul>	Clean fluid system (flush with clean, dry air or a non-aggressive cleaning liquid, e.g. ethanol or isopropyl alcohol)
	Sensor failure	Contact your Bronkhorst representative
Mode/MOD and Error/NET LEDs blinking red alternately, no communication	Initialization error	Restart instrument. If problem persists, contact Bronkhorst
Red LED lit continuously or flickering, measurement readout irregular	Combined gas and liquid flow in measuring tube (slug flow)	Flush system to remove gas (see <% TARGETTITLE%>)
	Upstream pressure unstable (flow rate pulsating)	Eliminate pressure fluctuations, e.g. by installing a pressure regulator
Red LED lit continuously, no flow	Hardware failure	Contact your Bronkhorst representative

Symptom	Possible cause	Corrective action
<ul style="list-style-type: none"> <li>Control behavior unstable</li> <li>Red LED flickering</li> </ul>	Upstream pressure unstable	Install pressure regulator or increase buffer volume between controlling instruments
	Gas accumulation in tubing	Remove gas from liquid tubing (see <a href="#">First use</a> )
	Wrong controller settings	Adjust settings (e.g. with FlowPlot)
	Control valve damaged	Contact your Bronkhorst representative
No flow (sending a setpoint has no effect)	No fluid supply	<ul style="list-style-type: none"> <li>Check fluid inlet</li> <li>Check upstream components for obstruction</li> </ul>
	Setpoint too low	Give setpoint $\geq 2\%$
	Actuator cable disconnected or damaged	Check actuator cable
	Wrong control mode selected	<ul style="list-style-type: none"> <li>Check parameter <a href="#">Control mode</a></li> <li>Make sure instrument accepts setpoint from actual setpoint source (bus/RS-232/analog)</li> </ul>
	Valve(s) in default state (normally closed)	Check if valves are in default state; solve cause if necessary (see <a href="#">Default valve state</a> )
	Upstream pressure too low	Increase upstream pressure (to a value within specifications)
	Downstream pressure too high	Decrease downstream pressure (to a value within specifications)
	Differential pressure too low	Make sure differential pressure is within specifications
	<ul style="list-style-type: none"> <li>Fluid system clogged or blocked</li> <li>Sensor obstructed or contaminated</li> </ul>	Clean fluid system (flush with clean, dry air or a non-aggressive cleaning liquid, e.g. ethanol or isopropyl alcohol)
Flow rate never reaches setpoint	<ul style="list-style-type: none"> <li>Piping, filters and/or control valve clogged or blocked</li> <li>Sensor obstructed or contaminated</li> </ul>	Flush fluid system with clean, dry air or non-aggressive cleaning liquid (e.g. ethanol or isopropyl alcohol)
	Upstream pressure or differential pressure too low	<ul style="list-style-type: none"> <li>Check/increase upstream pressure</li> <li>Use instrument in conditions it was designed for</li> </ul>
	Downstream pressure too high	<ul style="list-style-type: none"> <li>Check/decrease downstream pressure</li> <li>Use instrument in conditions it was designed for</li> </ul>
	Process outlet blocked	Check process outlet and downstream piping
Measured value or output signal indicates flow, while there should be none	Fluid system leakage	<ul style="list-style-type: none"> <li>Check fluid system for leakage</li> <li>Follow mounting instructions when installing third party components (e.g. adapters, tubing, valves)</li> </ul>
	Mounting orientation and/or process conditions changed significantly	<ul style="list-style-type: none"> <li>Install instrument according to <a href="#">mounting recommendations</a></li> <li>Use instrument in conditions it was designed for</li> <li><a href="#">Adjust zero point</a></li> </ul>
	Zero point adjustment performed incorrectly	Readjust zero point, following instructions in <a href="#">Adjusting zero point</a>

Symptom	Possible cause	Corrective action
Continuous maximum measured value or output signal	Upstream pressure too high	Check upstream pressure
	Valve fully open	<ul style="list-style-type: none"> <li>• Check parameter <a href="#">Control mode</a></li> <li>• Close valve</li> <li>• In case of normally open valve: check if valve is in default state; resolve cause if necessary (see <a href="#">Default valve state</a>)</li> </ul>
	Sensor failure	Contact your Bronkhorst representative
Fluid system leakage	Bad connection between parts (e.g. ferrules, nuts, tubing, piping, valves)	Follow mounting instructions issued by third party components (e.g. adapters, tubing, valves)

### 8.3 Service

If you have a question about a product or if you find the product does not meet the specifications as ordered, do not hesitate to contact your Bronkhorst representative. To enable us to help you quickly and effectively, make sure to have the serial number (SN) ready whenever seeking contact with your Bronkhorst representative about a specific item.



For current information about Bronkhorst® and worldwide service addresses, please visit our website:

 [www.bronkhorst.com](http://www.bronkhorst.com)

Do you have any questions about our products? Our Sales department will gladly assist you selecting the right product for your application. Contact sales by e-mail:

 [sales@bronkhorst.com](mailto:sales@bronkhorst.com)

For after-sales questions, help and guidance, our Customer Care department is available by e-mail:

 [aftersales@bronkhorst.com](mailto:aftersales@bronkhorst.com)

No matter the time zone, our experts within the Customer Care department are available to answer your request immediately or take appropriate further action. Our experts can be reached at:

 **+31 859 02 18 66**

Bronkhorst High-Tech B.V.  
Nijverheidsstraat 1A  
NL-7261 AK Ruurlo  
The Netherlands

## 9 Returns

### 9.1 Removal and return instructions

When returning materials, always clearly describe the problem, and, if possible, the work to be done, in a covering letter.

#### Instrument handling:

1. Purge all fluid lines (if applicable)
2. If the instrument has been used with toxic or otherwise hazardous fluids, it must be cleaned before shipping
3. Disconnect all external cabling and tubing and remove the instrument from the process line
4. If applicable, secure movable parts with appropriate transport safety materials, to prevent damage during transportation
5. The instrument must be at ambient temperature before packaging
6. Insert the instrument into a plastic bag and seal the bag
7. Place the bag in an appropriate shipping container; if possible, use the original packaging box

#### Add documentation:

- Reason of return
- Failure symptoms
- Contaminated condition
- Declaration on decontamination



***It is absolutely required to notify the factory if toxic or dangerous fluids have been in contact with the device!***  
*This is to enable the factory to take sufficient precautionary measures to safeguard the staff in their repair department.*

*All instruments must be dispatched with a completely filled in 'Declaration on decontamination'. Instruments without this declaration will not be accepted.*



*A safety information document containing a 'Declaration on decontamination' form (document no 9.17.032) can be downloaded from the **Service & Support** section of the Bronkhorst website ([www.bronkhorst.com](http://www.bronkhorst.com)).*

#### Important:

Clearly note, on top of the package, the customs clearance number of Bronkhorst High-Tech B.V.:

**NL801989978B01**

(only if applicable, otherwise contact your Bronkhorst representative for local arrangements.)

### 9.2 Disposal (end of lifetime)

If you are a customer within the European Union and wish to dispose of Bronkhorst® equipment bearing the symbol of a crossed out waste disposal bin, you can return it in accordance with the [removal and return instructions](#). Bronkhorst will then take care of proper dismantling, recycling and/or reuse (wherever possible). In the covering letter, mention that you are returning the product for disposal.

In countries outside the EU, disposal of electrical and electronic equipment (EEE) may be subject to local or national directives and/or legislation. If applicable, consult local or national authorities to learn how to handle EEE properly in your area.





## Parameter index

### Parameters

#### Parameters - Alarms

Alarm Delay Time	28
Alarm Info	28
Alarm Maximum Limit	29
Alarm Minimum Limit	29
Alarm Mode	28
Alarm New Setpoint	29
Alarm Setpoint Mode	29
Reset Alarm Enable	29

#### Parameters - Controller

Controller Speed	34
Normal step response	35
Open from zero response	35
PID-Kp	34
PID-Td	35
PID-Ti	34
Stable situation response	35

#### Parameters - Counter

Counter Limit	30
Counter Mode	30
Counter New Setpoint	31
Counter Setpoint Mode	31
Counter Unit	30
Counter Value	30
Reset Counter Enable	31

#### Parameters - Device identification

BHT Model Number	36
Customer Model	36
Device type	37
Firmware version	36
Identification number	36
Serial Number	36
User Tag	36

#### Parameters - Fluid

Capacity 100%	33
Capacity Unit	33
Fluid Name	33
Speed of Sound	33

#### Parameters - Master/Slave

Master Node	35
Slave Factor	36

#### Parameters - Measurement and control

Analog Input	27
Fmeasure	27
Fsetpoint	27

Measure	26
Setpoint	26
Setpoint Slope	27
Temperature	27
Valve Output	27

#### Parameters - Network configuration

Fieldbus1 Address	32
Fieldbus1 Baud Rate	32
Fieldbus1 Parity	32
Fieldbus2 Address	32
Fieldbus2 Baud Rate	32
Fieldbus2 Parity	32

#### Parameters - Special

Control Mode	37
Init Reset	37
IO Status	38
Reset	37
Wink	37